



# STAR PANEL INSTALLATION MANUAL

V-5-21

## Congratulations on your purchase of your new star panel system!

epiXsky is the **ORIGINAL MANUFACTURER** of the most advanced LED star ceiling technology on the market today!



### PACKAGE CONTENTS

In this kit you will find the following:

- Acoustical fiber optic panels
- Mounting anchors
- Epic Link
- RJ45 Quick Connect Cables
- Hex Tool
- Poker Tool
- 12V Power Supply
- Spacers\*

Some installers use spacers for standard installation requiring more room for wires.

**Note:** Sometimes there will be more than one lead wire and sometimes the wire(s) will already be attached to the power supply.

### WHAT YOU WILL NEED

For a smooth installation we highly recommend the following:

- Chalk line reel
- Painters tape or a light adhesive masking tape
- Sharp X-acto Knife or box cutter
- 3M Adhesive spray
- Ladder
- A work buddy



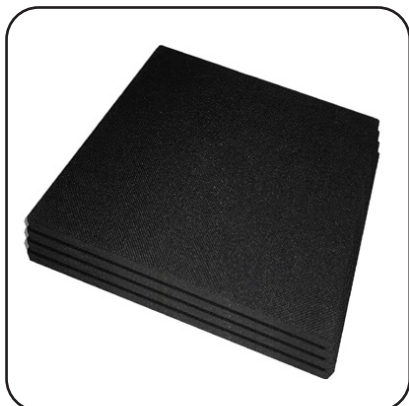

**ACOUSTICAL FIBER  
OPTIC PANELS**

1 INCH THICK & COME IN  
STANDARD SIZES OF 2'X2', 2'X4',  
4'X4', 4'X6' AND 4'X8'.



**MOUNTING  
ANCHORS**



**HEX TOOL**

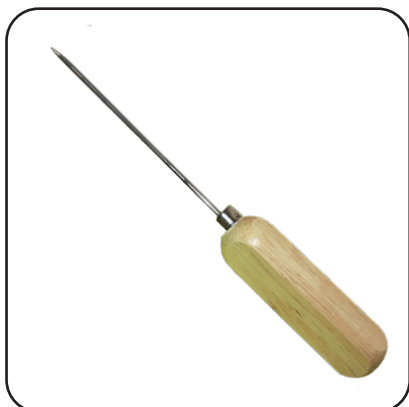

**POKER TOOL**



**SPACERS**



**RJ45 QUICK  
CONNECT CABLES**



**12V POWER SUPPLY**

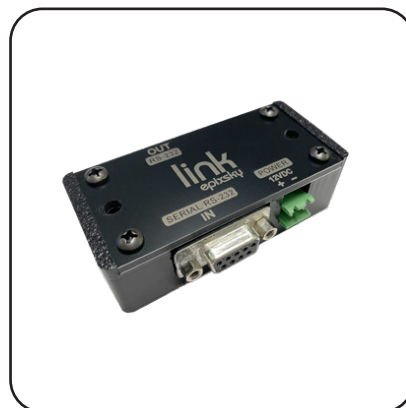

**EPIC LINK**





THE MOST IMPORTANT STEP INSTALLING YOUR STAR CEILING PANELS IS STARTING FROM THE **CENTER OF YOUR ROOM AND WORKING OUT.**

**1**

Find the center of the room by marking out an X from corner to corner

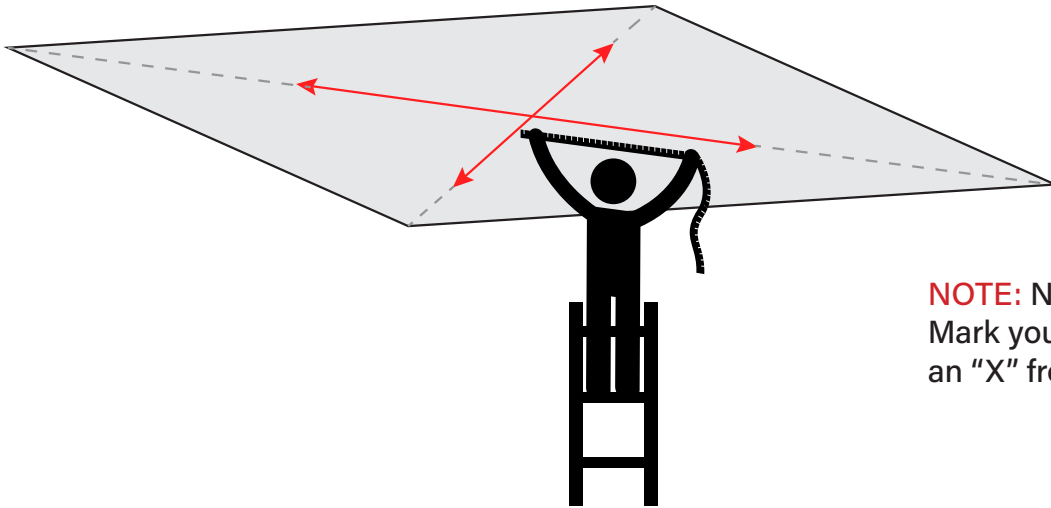

**NOTE:** Not every room is square! Mark your center by marking out an "X" from corner to corner.



EXACT MEASUREMENTS ARE CRITICAL. TAKE YOUR TIME. USE A CHALK LINE FOR MARKING.

**2**

Measure out a panel grid from the center out using a chalk line for guides. Your grid will correspond to the size panels you ordered. 24" x 24" or 24 x 48"

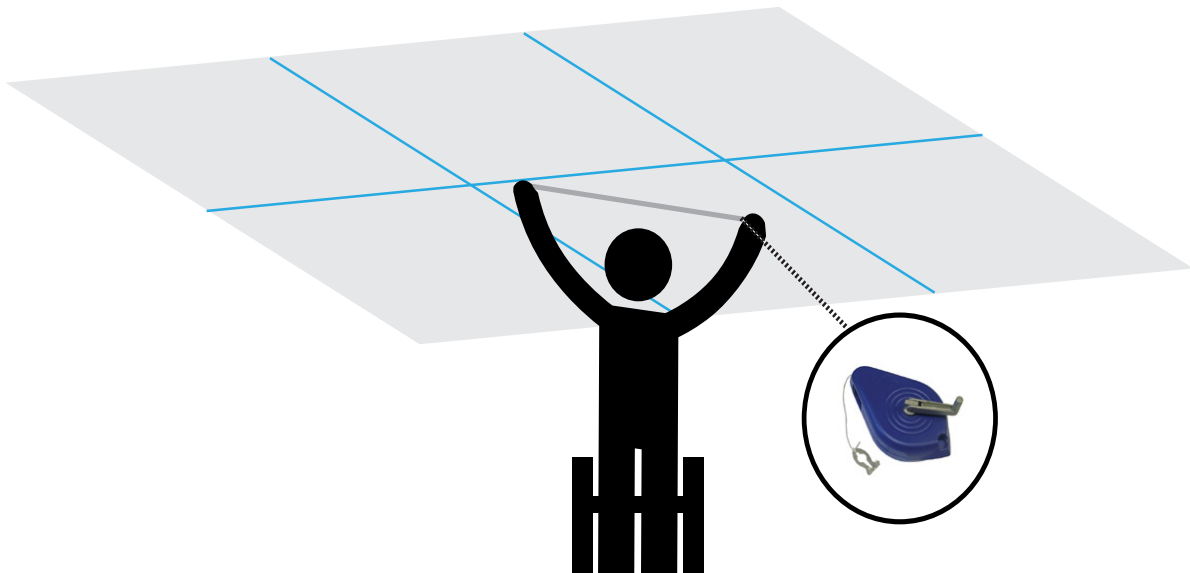



**HELPFUL HINT:** Before poking a hole with the Poker tool, place a piece of painters tape on the inside corners of each panel front. This way you can see where you have poked your hole when it comes time to screw in your roto fasteners

**3**

Hold up your first panel to the chalk line, and using the poker tool provided, poke a hole through each corner of the panel and into the ceiling.

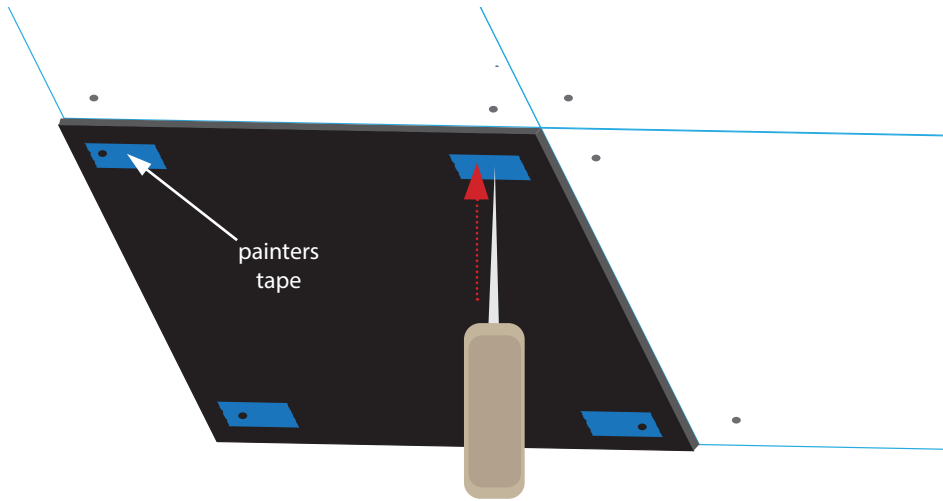

**NOTE:** poke holes approximately 4" in from each panel corner.

**4**

Screw in Roto Fasteners into the ceiling where you poked the

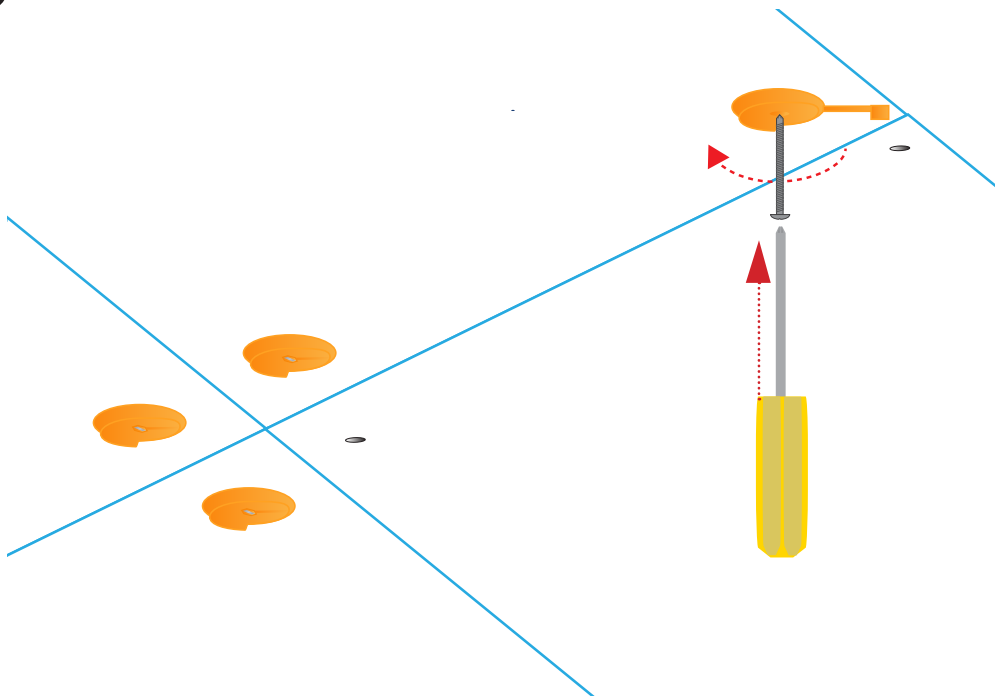

**NOTE:** When Rotofast is securely screwed into the ceiling, snap the attached hex cover into place.

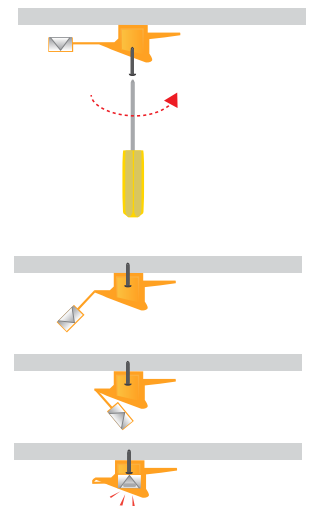

## INSTALLATION STEPS FOR SURFACE MOUNT

6

- 5** Connect the lead RS232 jumper cable coming from the Epic Link to the starboard. Make sure the RJ45 connector is placed into the IN port first panel you are installing. Connect your shorter jump wire into the OUT port that will lead to the IN port of your next panel to be placed. Refer to wiring diagram on page 3 for connection instructions.

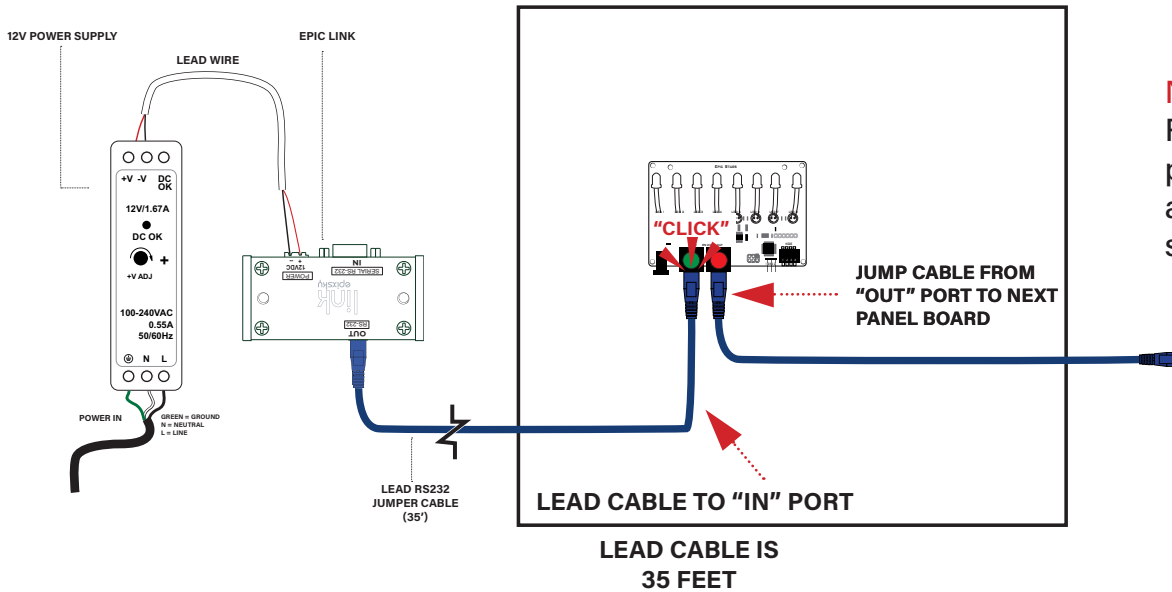

- 6** Place Star Panel back up to template and line up holes to installed Rotofast anchors. This is where you want a partner to help hold and line up panels.

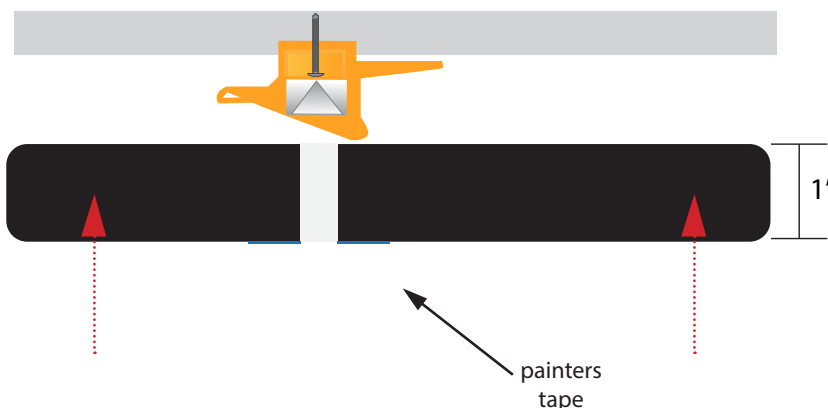

**NOTE:** If you used painters tape to mark your holes lining up your star panels to anchors will be easy!



- 7** Screw in Rotofast anchors into the ceiling using HEX tool to push and tighten *counterclockwise*. Use *gentle pressure and slow turns with the HEX tool*. It may take a few turns to engage the fastener. A firm connection is desired but it is very important to not over tighten rotofast.

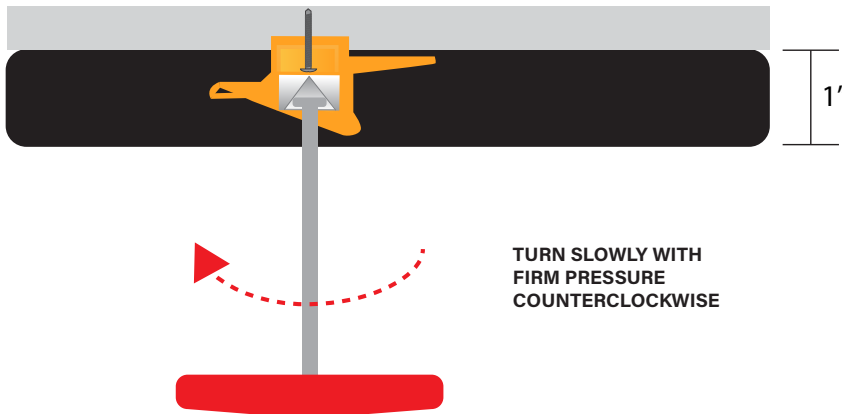

**NOTE:** DO NOT OVER  
TIGHTEN ROTOFAST  
ANCHOR.

- 8** Repeat process, installing your next panel and connecting your jump wires into the correct IN and OUT ports. Make sure to use gentle pressure and that each panel is level and flush to adjoining panels for a smooth overall surface



**NOTE:** Remember to  
work from inside out.

# INSTALLATION STEPS FOR ALL STAR™ DROP CEILING PANELS

- 1** Connect the lead wire coming from the Epic Link to the starboard. Make sure the RJ45 connector is placed into the IN port first panel you are installing. Connect your shorter jump wire into the OUT port that will lead to the IN port of your next panel to be placed. Refer to wiring diagram on page 3 for connection instructions.

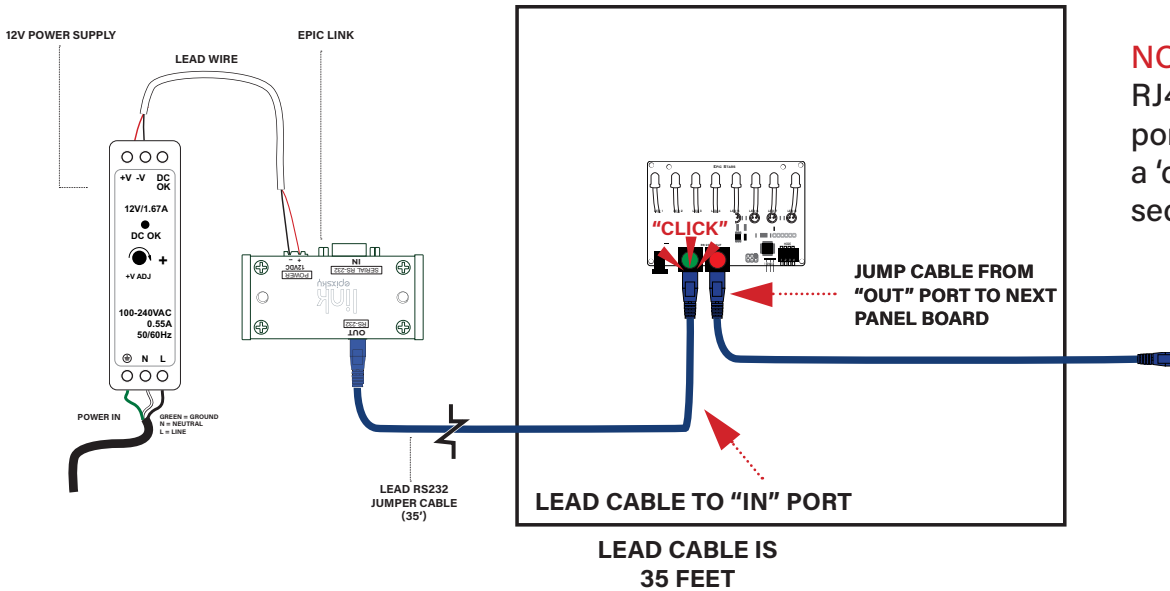

- 2** Insert Star Panel into drop ceiling frame.

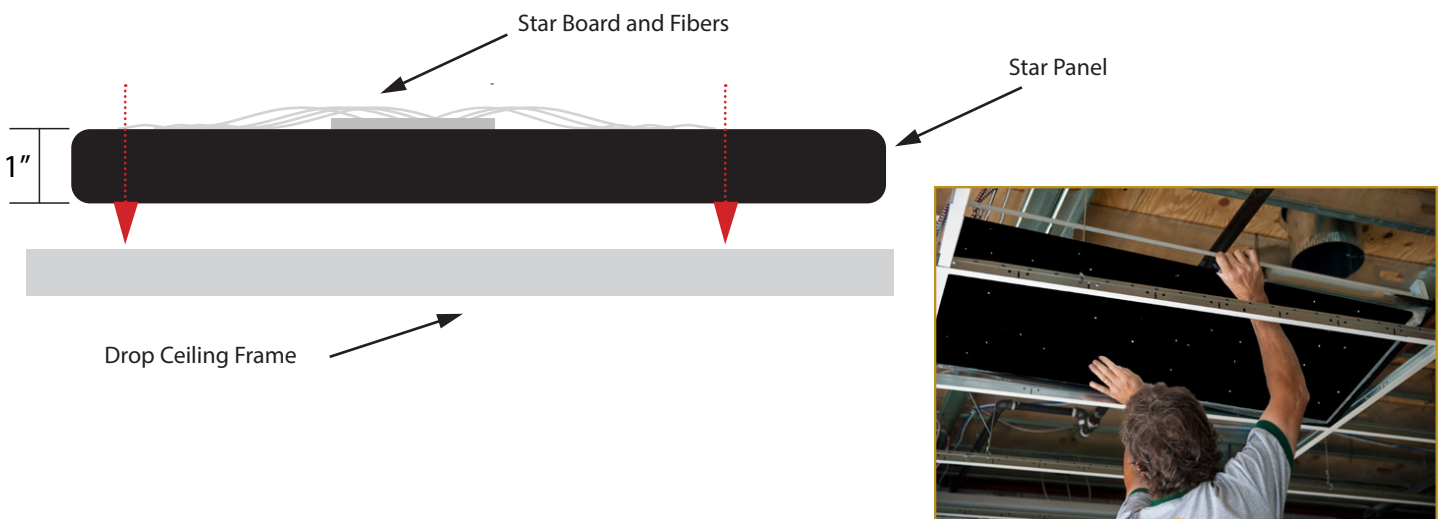

**NOTE:** Always cut on a flat surface. Spare cardboard works great. Make sure your knife is sharp so you don't tear or pull the fabric

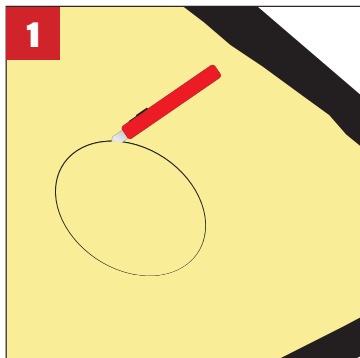

To field cut star panels for protruding objects such as drop beams, canned lights, or air conditioning vents, mark the location of the protrusion on the upper (unfinished) side of the panel. Use a sharp **NON-SERRATED** knife or box cutter. Cut the desired shape down through the fiberglass but **NOT THROUGH THE FABRIC**. Set your knife blade. Take your time!

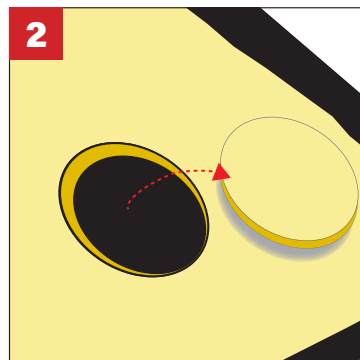

Remove the cut fiberglass piece from the panel.

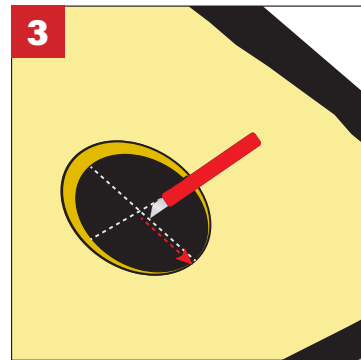

Carefully cut a clean "X" into the center of the fabric.

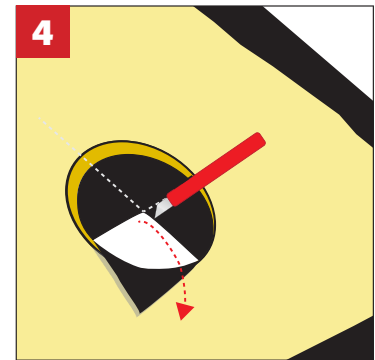

Fold flaps back through the opening.

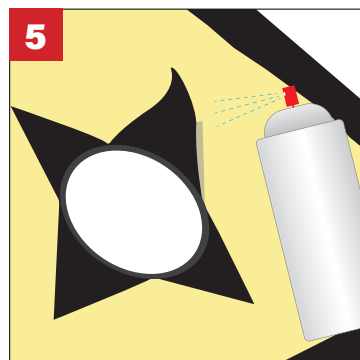

Spray back of loose flaps with a 3M super 77 spray and press flat to surface

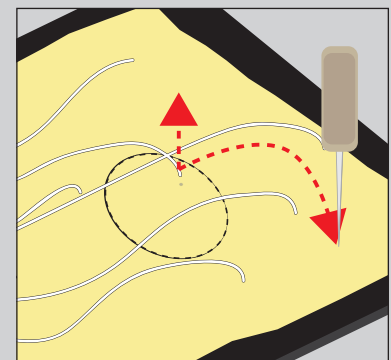
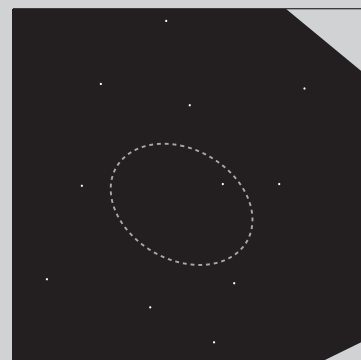

If a fiber or 2 is placed in a location you need to cut out simply cut the fiber, use the poker tool to make another hole in a location you desire, and push fiber through.  
*(It may not be necessary to do this as each board is populated evenly.)*

STAR EFFECTS are determined by the dip switches. The dip switch settings allow you to control a variety of effects including sparkle, scintillation, rain, strobe, etc.).

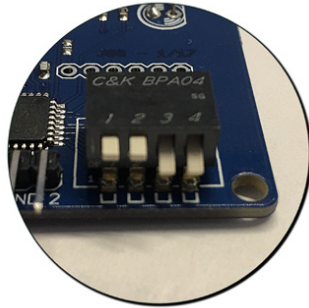

*Shooting Star 10 Min Setting Shown Above*

MODE	SWITCH 1	SWITCH 2	SWITCH 3	SWITCH 4
Night Sky	Up	Up	Up	Up
All on 50%	Down	Up	Up	Up
All On 25%	Up	Down	Up	Up
Meteor Shower	Down	Down	Up	Up
Night Sky 50%	Up	Up	Down	Up
Scintillation	Down	Up	Down	Up
Tropical Winds	Up	Down	Down	Up
Constellation Mode	Down	Down	Down	Up
Shooting Star 10 Sec	Up	Up	Up	Down
Shooting Star 1 Min	Down	Up	Up	Down
Shooting Star 2 Min	Up	Down	Up	Down
Shooting Star 5 Min	Down	Down	Up	Down
Shooting Star 10 Min	Up	Up	Down	Down
Rain Mode	Down	Up	Down	Down
Party (Strobe) Mode	Up	Down	Down	Down
All on 100%	Down	Down	Down	Down
<b>*NOTE*</b>	Epic Star Boards will read the DIP switch setting on power up. Check that the boards are in the right mode <b>before installing</b> in a ceiling.			

All commands must be terminated by a carriage return. All commands are repeated out the serial port to pass to the next controller or device. The "E" symbol means that those command values are stored in EEPROM and will load on power up.

COMMAND	ACTION	NOTES
ess	Night Sky	Night Sky in 3D perspective
ess1	Night Sky 50%	Night Sky in 3D perspective at 50% brightness
es2	Scintillation	Scintillation
es3	Tropical Winds	Tropical Winds - Fast Sparkle
esr	Rain Shower	Stars in Rain Shower mode
est	Party Mode	Stars all on with strobe/fade out pattern
esldxxx *E	Stars on Solid	xxx is the level, 1 - 255, 255 is the brightest
ecn	Constellations on Solid	All LED's on solid - separate than star commands
ecsp	Constellation Sparkle	Constellations sparkle
eco	Constellation Off	Only Constellations turn off
eclvxxx *E	Constellation Solid Level	xxx is the level, 1 - 255, 255 is the brightest
!	Trigger Shooting Star	Immediately trigger shooting star
ssj	Shooting Star 10 Seconds	Shooting Star every 10 seconds, Adjustable via RS-232
ss1	Shooting Star 1 Minute	Shooting Star every minute
ss2	Shooting Star 2 Minutes	Shooting Star every 2 minutes
ss5	Shooting Star 5 Minutes	Shooting Star every 5 minutes
ssz	Shooting Star 10 Minutes	Shooting Star every 10 minutes
sso	Shooting Star Off	Boards in shooting star mode will turn off
ssg	Shooting Star On	Shooting star on
mso	Meteor Shower On	Meteor Shower mode (DIP switches must be set correctly) Default rate is every 2 minutes
msf	Meteor Shower Off	Stops the meteor shower
ssd	Power on Setting	Return to Power on DIP Switch Setting
esdmxxx *E	Dim Setting (stars only)	Brightness level of stars, 1 to 255, Default is 255 (brightest)
espkxxx *E	Star Sparkle Speed	Sparkle Speed, 0 - 255, default is 17, the higher the number, the slower the sparkle
mtspxxx *E	Meteor Shower Speed	xxx is the The Speed of the Meteors in the Shower, 0 - 255, Default is 50 (higher is slower)
mtmxxx *E	Time Between Meteors	Time in 1/10's of a second between each meteor in the shower (0-255) default is 7
mtinxxx *E	Meteor Shower Interval	Time in seconds between meteor showers (0-255) default is 120
mtnmxxx *E	Meteor Number	Number of meteors per shower (1-255) default is 19
ssspxxx *E	Shooting Star Speed	xxx = 0 (fastest) to 254 (slowest), default is 40
sstmxxx *E	Shooting Star Interval	Interval Between Shooting Stars in seconds, 0 - 255, Default is 10
eso	Stars Off	All Stars Off
esn	Stars On	Turns on the stars in the last mode they were in
globaloff	All Off	All Stars off, regardless of mode
<b>NOTE:</b>	The Epic Star Boards will read the DIP switch setting on power up, check that the boards are in the right mode before installing in a ceiling.	

## Impact Lighting, Inc. TERMS AND CONDITIONS

### 1. Contract

No quotation or order acknowledgment to terms of these terms and conditions shall be changed in any respect except as specifically agreed to in writing and signed by an authorized officer of Impact Lighting, Inc. No statement, representation or warranty not contained herein shall be binding on Impact Lighting, Inc., unless made in writing and signed by an authorized officer of Impact Lighting, Inc.

### 2. Payment

Unless other arrangements have been authorized by our office in writing, all orders require a 50% deposit to accompany any purchase order or proposal acceptance, with balance due and paid prior to shipment. Payments must be made directly to Impact Lighting, Inc. Payments made otherwise are unauthorized, as there are no other parties authorized to collect money for Impact Lighting, Inc. and thus payments made to other parties or entities are made at purchaser's own risk. ONCE AN ORDER HAS BEGUN PRODUCTION IT CANNOT BE CANCELED. Changes to orders are subject to a change order process and may incur additional fees and extend lead times.

### 3. Prices

Price quotes can be obtained from authorized Impact Lighting, Inc. representatives ONLY. Quotations are firm for 30 days, and otherwise are subject to change without notice. Prices do not include freight or tax unless specifically noted.

### 4. Shipping Dates

Average shipping time is 4-6 weeks after receipt of order and deposit, however this can vary. Please consult your sales rep for expected shipping dates for specific orders. Our estimated shipping dates are our best approximation of a probable shipping date and shall not be deemed to present a fixed or guaranteed date. Impact Lighting, Inc. shall not be responsible for any damages, penalties or charge backs resulting from delayed shipments or from its inability to ship by the estimated shipping date.

### 5. Consequential Damage

Impact Lighting, Inc. shall not be liable for any consequential, contingent, or incidental damages whatsoever. Impact Lighting, Inc. is not liable for damages of any kind resulting from any delay or failure to deliver or perform due to strikes, lockouts, or other labor difficulties, or failure due to delay of sources of supply, transportation difficulties, accidents, fires, acts of God, or any other causes of like or unlike nature beyond Impact Lighting, Inc.'s control.

### 6. Installation and Limited Warranty

All of our products are manufactured with UL, ETL, or CE approved components. All fixtures shown in our catalog conform to all applicable UL standards at the time of printing. Impact Lighting, Inc. reserves the right to change or improve the design or components of any of its products due to availability or changes in UL standards, without assuming any obligation to modify any product previously manufactured and without notice. All equipment is tested and inspected prior to shipment. All secondary parts warranties are carried by their respective manufacturers with typical industry standard warranty periods.

Buyer must inspect goods for any defects prior to installation, within 10 days of receipt. No claims will be accepted after 10 days. All goods must be installed and inspected by a qualified installer or electrician, as appropriate for the product. Impact Lighting, Inc. warrants its products to be free from defects in material and workmanship for one year from date of purchase. This warranty is limited to the correction of any such defect or the replacement of the defective item. This warranty does not cover labor, shipping or installation costs, and specifically excludes any product that has suffered from misuse, negligence or accident, if it has been used in a manner contrary to accepted normal use or to Impact Lighting, Inc.'s printed instructions, been improperly installed, overloaded, altered, tampered with, or otherwise abused in which any parts, including glass, have been reworked, repaired, or replaced outside of Impact Lighting, Inc.'s facility. This warranty specifically excludes finishes due to the unsuitability of many cleaning agents. There are no other express warranties including any warranty of merchantability or fitness for particular purpose. Impact Lighting, Inc. shall not be liable for consequential damages or cost of removal and re-installation of its products. This warranty is strictly limited to the original purchaser.

### 7. Returns and Cancellation of orders

All merchandise is custom made to order, and therefore we cannot accept returns or cancellations of an order. If the buyer, after approval of an order to Impact Lighting Inc. desires to cancel the order, and Impact Lighting Inc. accepts such, cancellation charges shall be 50% of the total price of the order or, if greater, the actual costs incurred by Impact Lighting Inc. with respect to the order at the time of cancellation.

epiXsky

A Division of Impact Lighting Inc.

3080 Lenworth Drive • Mississauga, ON L4X 2G1 • Email: sales@epiXsky.ca

epiXsky.ca